

MP/A

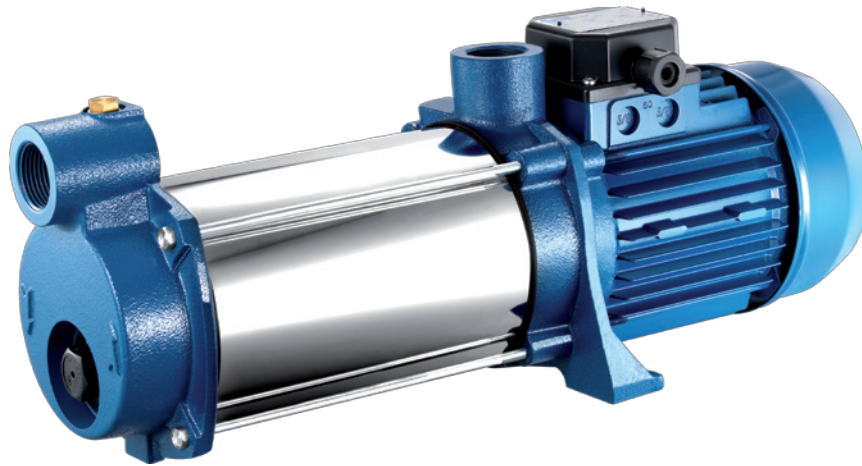

Pompe centrifughe multistadio, orizzontali e autoadescanti, particolarmente adatte alla realizzazione di piccoli e medi gruppi di pressurizzazione; in grado di aspirare liquidi miscelati ad aria o a gas.

Multi-stage centrifugal pumps, horizontal and self-priming, particularly suitable for constructing small and medium sized pressurisation systems; able to suck liquids mixed with air or gas.

Bombas centrifugas multicelulares, horizontales y autocebantes, particularmente apropiadas para realizar equipos de presión pequeñas y medianas; en condición de aspirar líquidos mezclados con aire o gas.

Pompes centrifuges multicellulaires, horizontales et auto-amorçantes, particulièrement indiquées à la réalisation de petits et moyens groupes de surpression; elles peuvent aspirer des liquides mélangés à de l'air ou du gaz.

CARATTERISTICHE COSTRUTTIVE / CONSTRUCTION FEATURES CARACTERÍSTICAS CONSTRUCTIVAS / CARACTÉRISTIQUES D'EXÉCUTION

Corpo pompa	ghisa
Pump body	cast iron
Cuerpo bomba	fundición
Corps de pompe	fonte
Supporto motore	ghisa
Motor bracket	cast iron
Soporte motor	fundición
Support moteur	fonte
Girante	
Impeller	Noryl®
Rodete	
Turbine	
Tenuta meccanica	ceramica-grafite
Mechanical seal	ceramic-graphite
Sello mecánico	cerámica-grafito
Garniture mécanique	céramique-graphite
Albero motore	acciaio AISI 416
Motor shaft	stainless steel AISI 416
Eje motor	acero AISI 416
Arbre moteur	acier AISI 416
Temperatura del liquido	
Liquid temperature	0 - 50 °C
Temperatura del líquido	
Température du liquide	
Pressione di esercizio	
Operating pressure	max 11 bar
Presión de trabajo	
Pression de fonctionnement	

MOTORE / MOTOR / MOTOR / MOTEUR

Motore 2 poli a induzione	3~ 230/400V-50Hz
2 pole induction motor	1~ 230V-50Hz
Motor de 2 polos a inducción	con termoprotettore
Moteur à induction à 2 pôles	with thermal protection
	con protección térmica
	avec protection thermique
Classe di isolamento	
Insulation class	F
Clase de aislamiento	
Classe d'isolation	
Grado di protezione	
Protection degree	IP44
Grado de protección	
Protection	

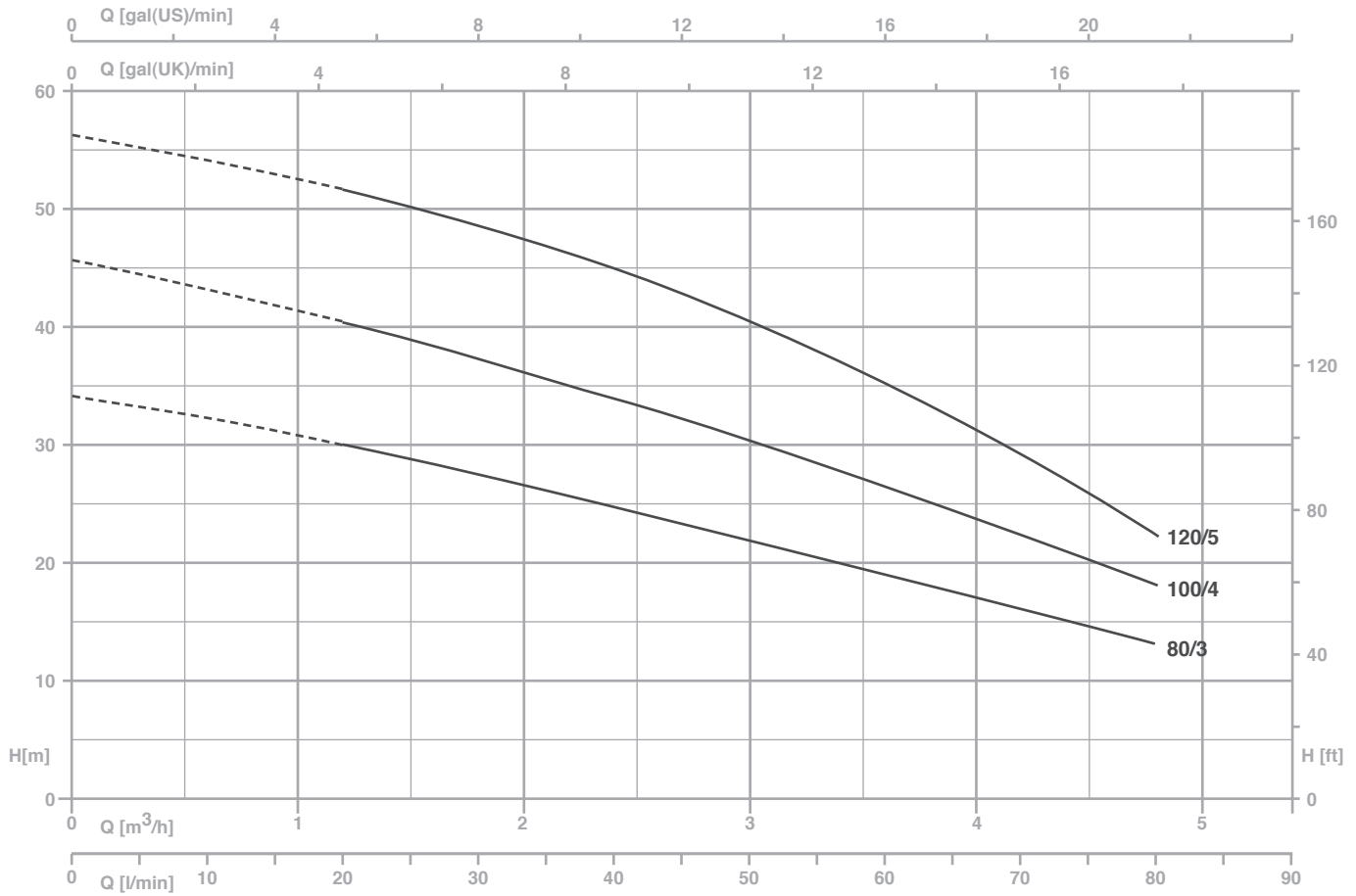

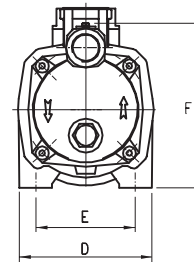
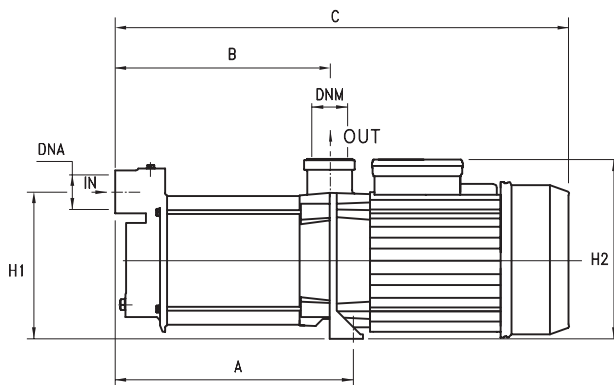

TYPE		P2		P1 (kW)		AMPERE		Q (m³/h - l/min)						
1~	3~	(HP)	(kW)	1~	3~	1~	3~	0	1,2	1,4	3,6	4,8		
								0	20	40	60	80		
						1x230 V 50 Hz		3x400 V 50 Hz		H (m)				
MP 80/3 A	MPT 80/3 A	0,8	0,59	0,83	0,88	3,8	1,6	34	29,5	25	18,5	13		
MP 100/4 A	MPT 100/4 A	1	0,74	1,07	1,1	5	1,9	45,5	40	34	26	18		
MP 120/5 A	MPT 120/5 A	1,2	0,88	1,27	1,33	6,1	2,3	56	51,5	44,5	35	22		

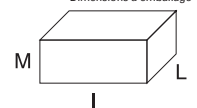

Dimensioni imballo
Package dimensions
Dimensiones embalaje
Dimensions d'emballage



TYPE	DIMENSIONS (mm)													
	A	B	C	D	E	F	H1	H2	DNA	DNM	I	L	M	
MP 80/3 A	245	224	425	180	140	185	150	175	1" G	1" G	440	200	215	14
MP 100/4 A	270	240	450	180	140	185	150	175	1" G	1" G	500	200	215	15,7
MP 120/5 A	295	264	475	180	140	185	150	175	1" G	1" G	500	200	215	16