

Product Type: r_type

Product name: CDL(F)1-36
Product No.: 1030149

Technical:

Speed for pump data: 2900 rpm
Rated flow: 1 m³/h
Flow range: 0.4~2 m³/h
Rated head: 200 m
Curve tolerance: ISO 9906 Annex A

Materials:

Diffuser\Impeller: 304/316L
CDLPump head\Inlet and outlet chamber: HT200
CDLFSeal base\Inlet and outlet chamber: 304/316L
code for rubber: NBR/EPDM

Installation:

Maximum ambient temperature: Max.+40 °C
Connet code: Flange PN25/DN25
Shaft seal: CDLA-12

Liquid:

Liquid temperature: Normal temperature type-15°C~+70°C; Hot wanter type-15°C~+120°C

Electrical: :

Phase: single-phase/Three-phase
Driving motor: 2.2kW
Mains frequency: 50Hz
Protection class: IP55
Insulation class: F

Others: :

Net weight: 45kg



Product Type: r_type

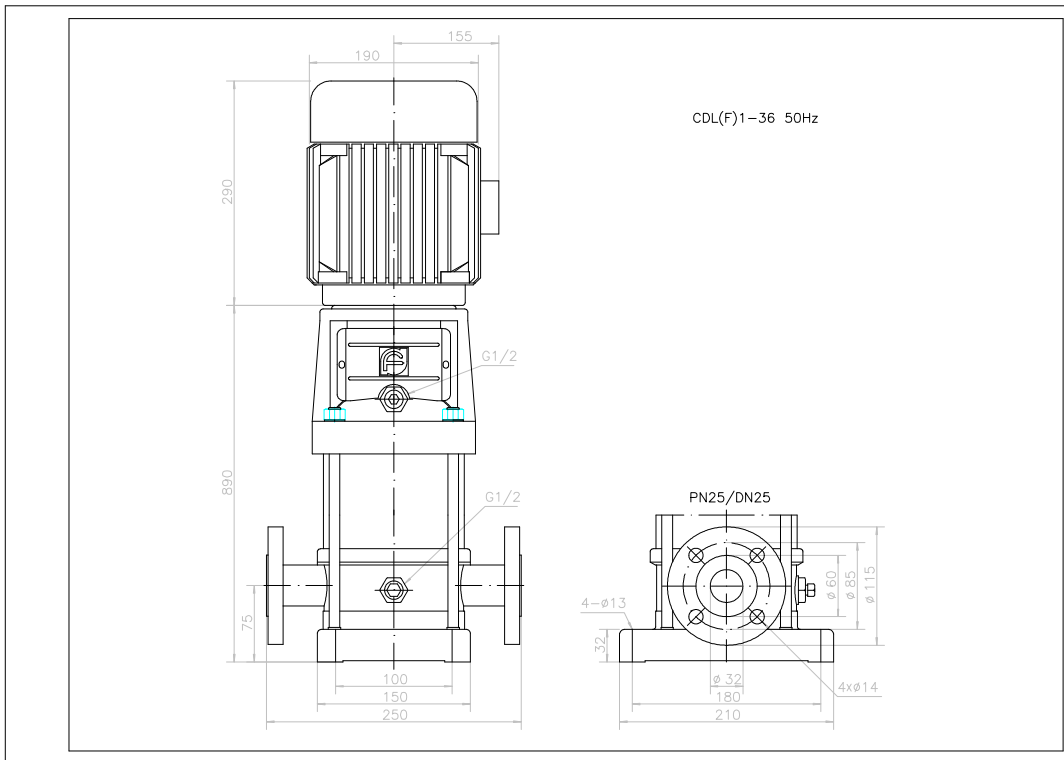
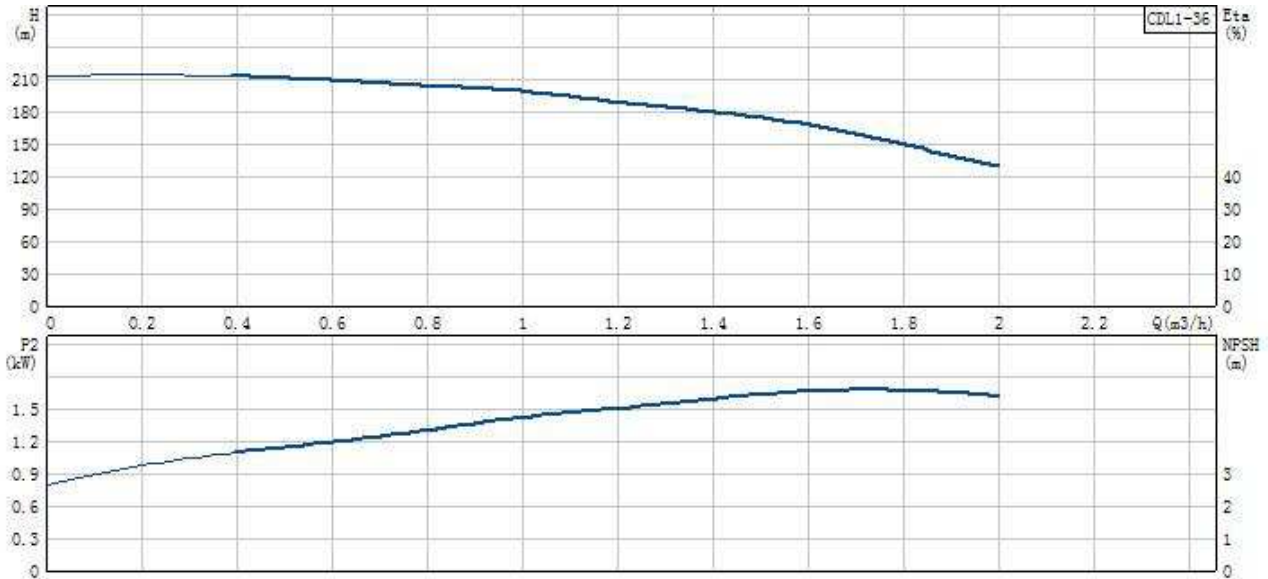

Product Type: r_type

